

A.R.I. D-46



Waterworks

Full-bore, Combination Air Valve Series

Description

A.R.I. D-46 is a full-bore, single-body, Combination Air Valve Series. Installed on liquid transmission systems, the Air Valve is designed to improve hydraulic operation by protecting the pipeline, increasing pipeline efficiency and reducing energy requirements. The Air Valve provides high-capacity air release and intake.

Installation

- Pump stations: after the pump and after the check valve
- Downstream (after) and upstream (before) of shut-off valves
- After deep-well pumps
- On long constant-sloped pipeline segments
- At peaks along the pipeline and at peaks relative to hydraulic gradient
- At end lines
- Before water meters
- On strainers and filters

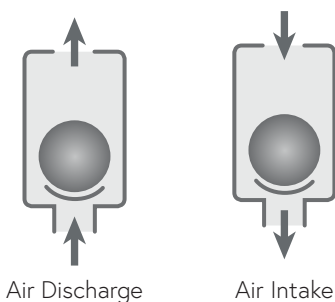

Operation



Air Discharge

Air Intake

Features and Benefits

Flow cross-sections	Equal to or greater than nominal port area
Single-body design	Easy to install and maintain, reduces downtime
Aerodynamic design	High-capacity air discharge, no premature closure
	Reduces water hammer impact
	Saves energy and increases system efficiency
Screen protected outlet	Prevents intrusion of insects and debris
Construction materials	Non-corrosive and durable
Automatic air release valve rolling seal	Leak-free sealing over a wide range of pressure differentials
Automatic air release valve orifice	High flow air release, lessens obstruction by debris
 ATEX certified air valves	ATEX certified air valves are optional by customer request. Certification is conditional upon the customer connecting the designated part on the product to a dedicated ground connection point
 NSF/ANSI/CAN 61 certified & listed	For drinking water system component
 NSF/ANSI 372 certified & listed	Conforms with lead content requirements for "lead-free" plumbing

Technical Specifications

Size range	2" -6"
Working pressure range	0.1-16 bar (PN 16) Testing pressure: 1.5 times maximum working pressure
Temperature	Maximum working temperature: 60° C Maximum intermittent temperature: 90° C
Coating	Fusion bonded epoxy coating in compliance with standard DIN 30677-2

Upon ordering, please specify: model, size, working pressure, thread / flange standard and type of liquid

Valve Selection Options

Valve connection	Threaded male BSPT/NPT (2"), Flanged ends to meet various requested standard (2"-6")
Standard materials	Cast ductile iron body
Optional Add-on Components	One-way, Out-only attachment, allows for air discharge only, prevents air intake Adjustable Non-Slam disc, can also be optionally retrofitted on existing D-46 air valves.
Additional Product Configurations	SB Underground Air Valve System
Models	Elbow Outlet Models, Screen Cover Models

The isolation valve installed under the air valve must be fully open to prevent damage or malfunction and ensure performance within the specifications of the air valve.

For complete installation instructions, please refer to the IOM document.

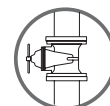

Dimensions and Weight

Size	Dimensions (mm)		Connections	Weight (kg)	Orifice Area (mm ²)		
	max. A	B			C	A / V	
Elbow Outlet Models							
2" (50mm) FL	202	336	2" BSP/NPT F	7.3	1963	15.0	
3" (80mm) FL	200	467	3" BSP/NPT F	13.0	5027	13.8	
4" (100mm) FL	220	537	4" BSP/NPT F	18.2	7854	13.8	
6" (150mm) FL	362	757	6" Grooved	43.6	18250	15.0	
Screen Cover Outlet Models							
2" (50mm) FL	165	301	NA	6.8	1963	15.0	
3" (80mm) FL	202	375	NA	12.8	5027	13.8	
4" (100mm) FL	235	425	NA	17	7854	13.8	
6" (150mm) FL	323	594	NA	43	18250	15.0	

FL - Flanged THR - Threaded

NOTE: The cover assembly with the discharge elbow can be set in four directions. Dimension A in the picture and in the table shows the maximum product width. This width can be reduced by changing the cover direction.

All product weights are approximate, due to the differences in flange standards, materials and variable accessories.

Flow Charts

Automatic Air Release Flow Rate

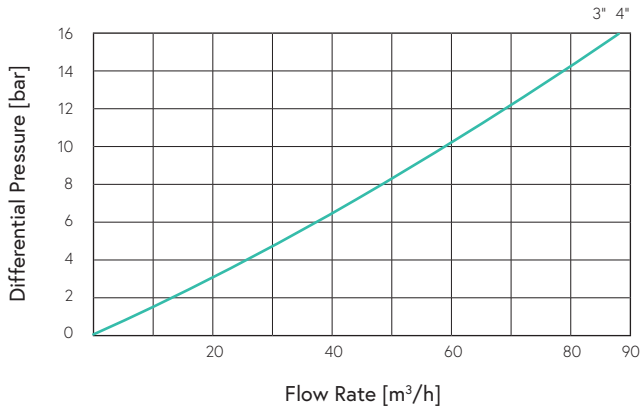

Automatic Air Release Flow Rate

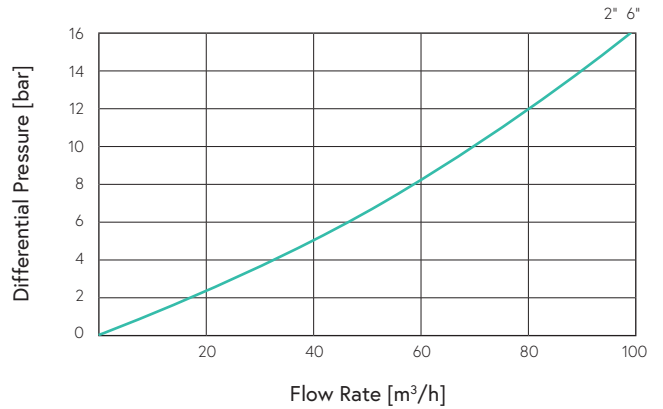

Elbow Outlet Models

Air & Vacuum Flow Rate

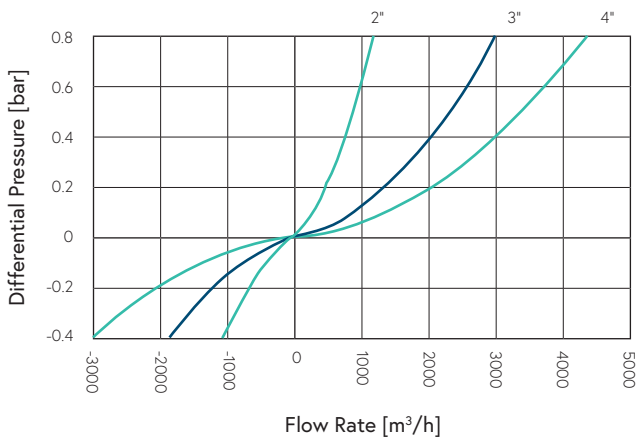

Air & Vacuum Flow Rate

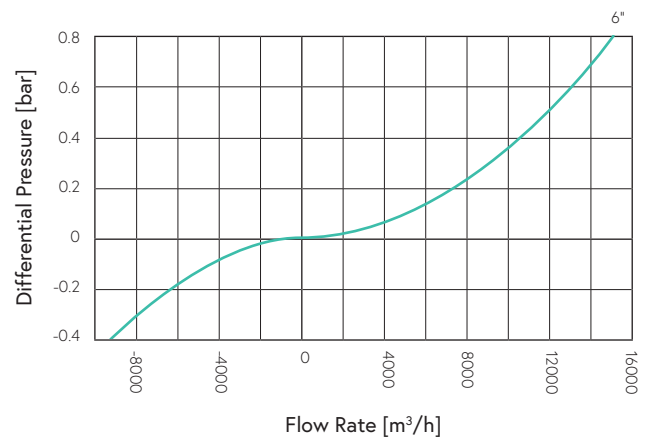

Screen Cover Outlet Models

Air & Vacuum Flow Rate

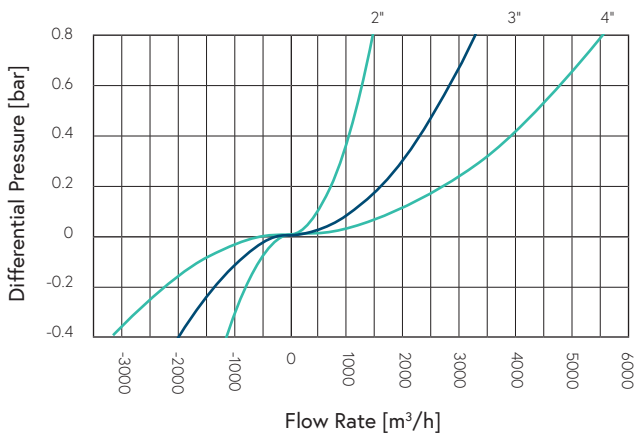

Air & Vacuum Flow Rate

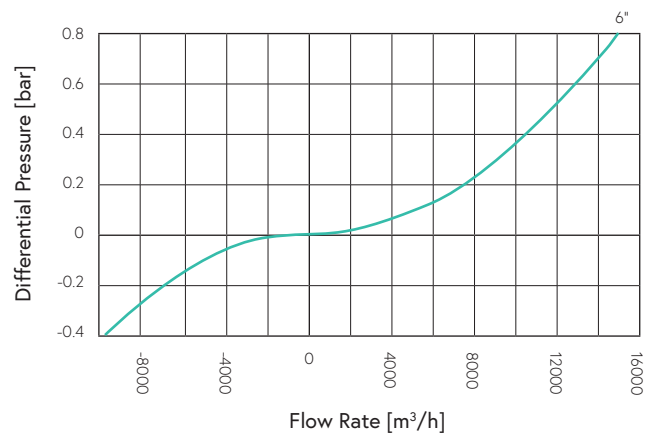

Non-Slam Add-on Component Data Table for Variable Orifices

Size	Discharge orifice (mm)	Total NS area (mm ²)	NS orifice (mm)	Switching point (bar)	Flow at 0.4 bar (m ³ /h)
2" (50mm)	50	78.5	10	0.007	65
3" (80mm)	80	184	15	0.004	180
4" (100mm)	100	397	22.5	0.005	235
6" (150mm)	150	884	34	0.03	725

Flow Charts

NS Elbow Outlet Models

Air & Vacuum Flow Rate

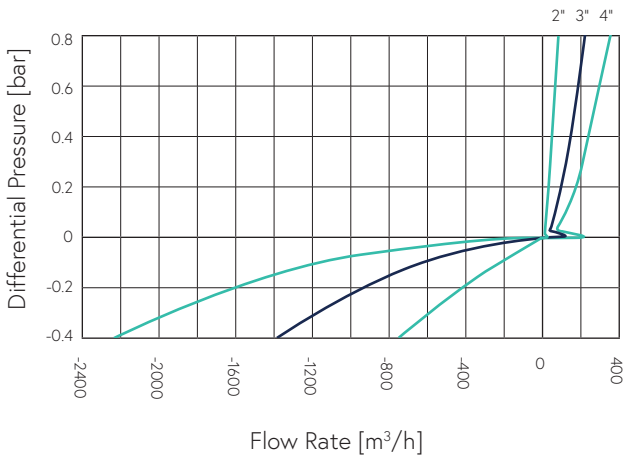

Air Discharge Switching Region

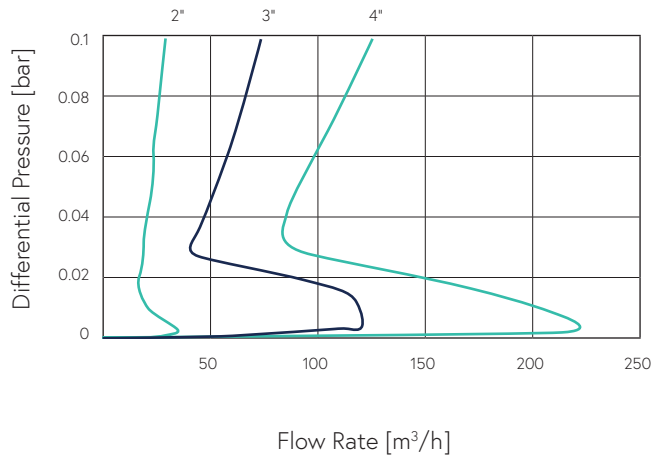

Air & Vacuum Flow Rate

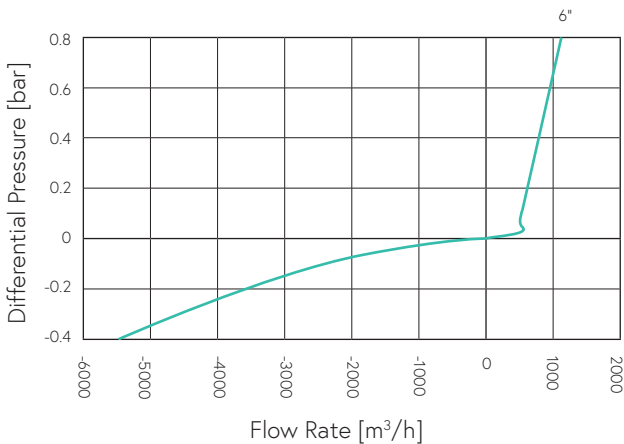

Air Discharge Switching Region

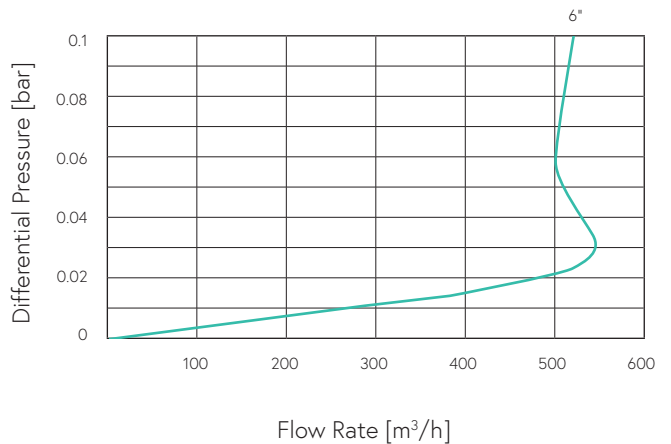

Flow Charts

NS Screen Cover Outlet Models

Air & Vacuum Flow Rate

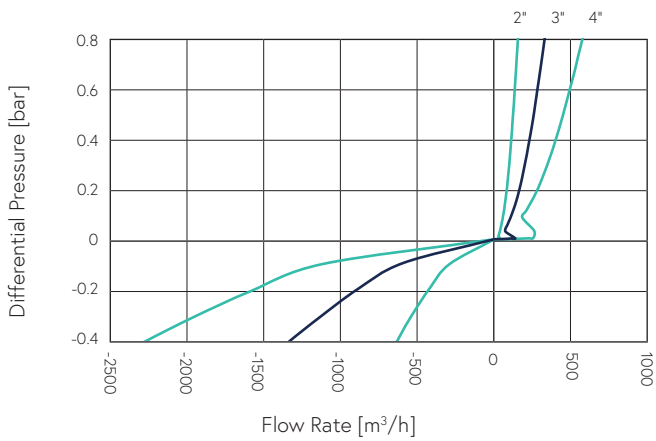

Air Discharge Switching Region

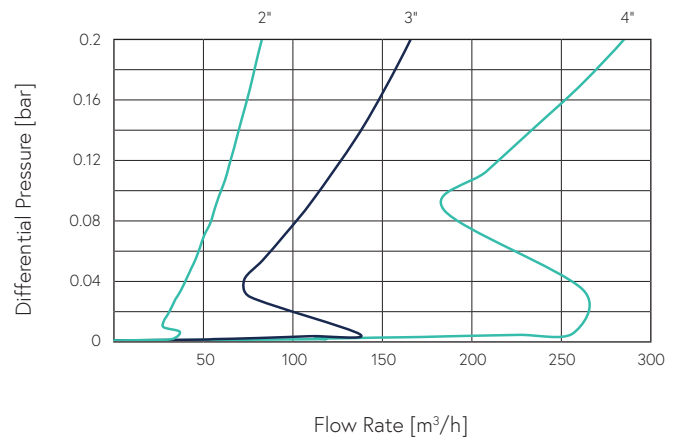

Air & Vacuum Flow Rate

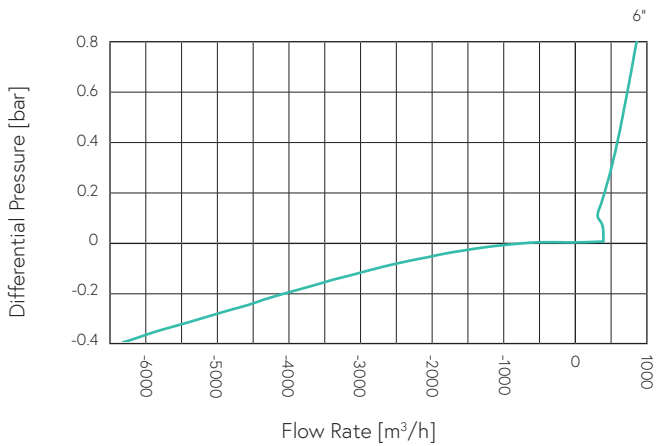

Air Discharge Switching Region

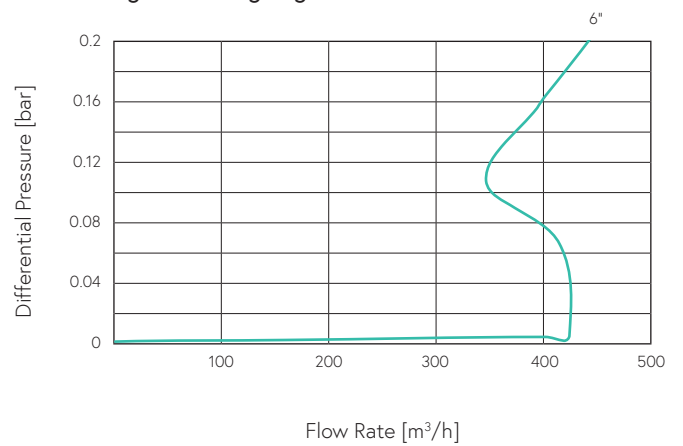

Parts List and Specification | 2"

No.	Part	Material
1	1. Discharge Assembly	
1a	1a. Discharge Elbow or Screen Cover	Polypropylene
1b	1b. Seal	NBR
2	2. Body Assembly	
2a	2a. Optional - Non Slam Disc	Reinforced Nylon
2b	2b. Body	Ductile Iron
2c	2c. Drain Outlet	Polypropylene
2d	2d. Pressure Release Plug	Reinforced Nylon
3	3. Air Release / Air & Vacuum Assembly	
3a	3a. Air & Vacuum Seal	EPDM
3b	3b. Air Release Cover	Acetal
3c	3c. Rolling Seal	EPDM
3d	3d. Float	Polypropylene
4	4. Seat Assembly	
4a	4a. Float Seat	Acetal
4b	4b. Snap Ring	Reinforced Nylon



Parts List and Specification | 3" 4"

No.	Part	Material
1	Discharge Assembly	
1a	Discharge Elbow or Screen Cover	Polypropylene
1b	Seal	NBR
2	Body Assembly	
2a	Optional - Non Slam Disc	Reinforced Nylon
2b	Body	Ductile Iron
2c	Drain Outlet	Polypropylene
2d	Pressure Release Plug	Reinforced Nylon
3	Air Release Assembly	
3a	Cover	Acetal
3b	O-ring	EPDM
3c	Rolling Seal	EPDM
3d	Air Release Float	Polypropylene
4	Air & Vacuum Assembly	
4a	Air & Vacuum Seal	EPDM
4b	Air & Vacuum Float	Polypropylene
5	Seat Assembly	
5a	Float Seat	Acetal
5b	Snap Ring	Reinforced Nylon

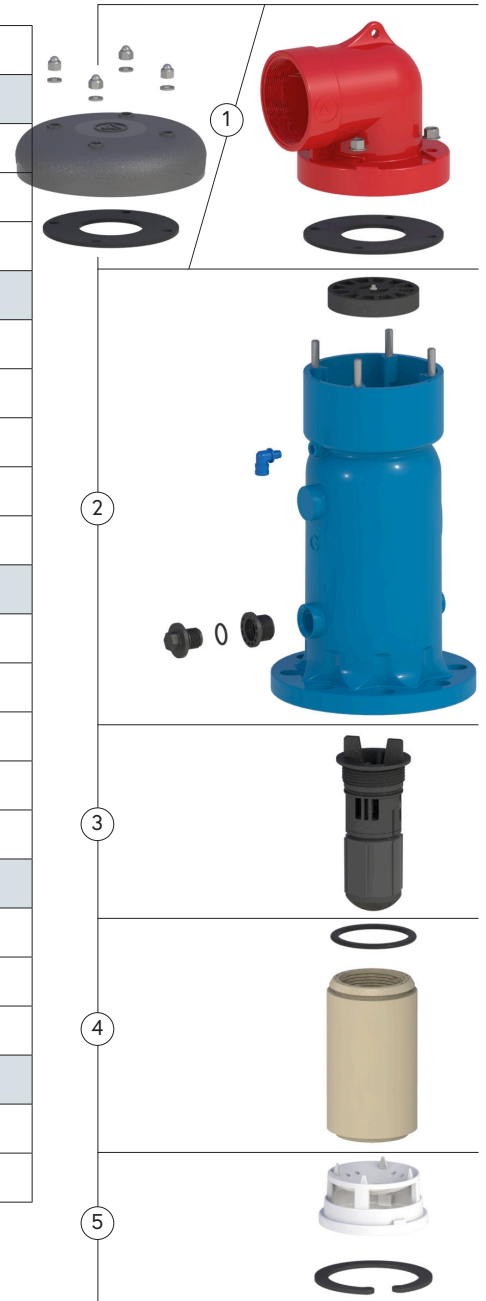

Parts List and Specification | 6"

No.	Part	Material	
1	1. Discharge Outlet Assembly		
Elbow Model	1a	1a. Discharge Elbow Outlet	Polypropylene
	1b	1b. Lifting Ring	Stainless Steel 316
	1c	1c. Seal	NBR
	1d	1d. Flange + Locking Ring + O-ring (Optional)	Polypropylene / Steel + Acetal+ EPDM
Screen Model	1a	1a. Screen Cover	Stainless Steel 316
	1b	1b. Lifting Ring	Stainless Steel 316
	1c	1c. Screen	Stainless Steel 316
	1d	1d. Screen Seat	Stainless Steel 316
2	2. Body Assembly		
2a	2a. Optional - Non Slam Disc	Reinforced Nylon	
2b	2b. Body	Ductile Iron	
2c	2c. Drain Outlet	Polypropylene	
2d	2d. Pressure Release Plug	Reinforced Nylon	
3	3. Air Release Assembly		
3a	3a. Cover	Reinforced Nylon	
3b	3b. O-ring	EPDM	
3c	3c. Rolling Seal	NBR	
3d	3d. Air Release Float	Foamed Polypropylene	
4	4. Air & Vacuum Assembly		
4a	4a. Air & Vacuum Seal	EPDM	
4b	4b. Air & Vacuum Float	Reinforced Polypropylene	
5	5. Seat Assembly		
5a	5a. Float Seat	Acetal	
5b	5b. Snap Ring	Acetal	
5c	5c. Flange Seal	EPDM	

