

A.R.I. K-060 NS



Industry

Full-bore, Non-slam, Air & Vacuum Air Valve Series

Description

A.R.I. K-060 NS is a non-slam, full-bore, Air & Vacuum Air Valve Series. Valve operation includes venting air from a filling pipeline and also vacuum breaking (air intake) of a draining pipeline, to optimize pipeline hydraulic efficiency and flow.



Installation

- Pump stations: downstream of the pump and the check valve
- Downstream and upstream of shut-off valves
- Downstream of deep-well pumps
- On long constant-sloped pipeline segments
- At peaks along the pipeline and at peaks relative to hydraulic gradient
- Water pipelines with anticipated conditions of surge and water hammer
- Water pipelines where water column separation occurs
- Municipal and industrial water conveyance systems

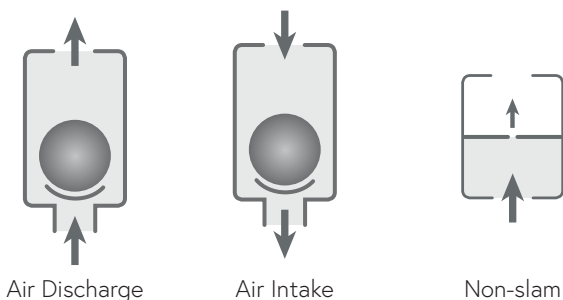
Operation



Features and Benefits

Flow cross-sections	Equal to or greater than nominal port area
Simple product design	Easy to install and maintain
Aerodynamic design	High-capacity air discharge, no premature closure
	Reduces water hammer impact
	Saves energy and increases system efficiency
Unique orifice seat / seal design	Long-term maintenance-free operation
Screen protected outlet	Prevents intrusion of insects and debris
Construction materials	Non-corrosive and durable
Automatic air release valve rolling seal	Leak-free sealing over a wide range of pressure differentials
Automatic air release valve orifice	High flow air release, lessens obstruction by debris
Non-slam (NS) device	Efficient surge suppression
 ATEX certified air valves	ATEX certified air valves are optional by customer request. Certification is conditional upon the customer connecting the designated part on the product to a dedicated ground connection point
 NSF/ANSI/CAN 61 certified & listed	For drinking water system component
	NSF/ANSI 372 certified & listed

Technical Specifications

Size range	1" - 10" 2" - 8" (K-065 NS only)
Working pressure range	A.R.I. K-060 NS 0.2 - 16 bar (PN16) A.R.I. K-062 NS 0.2 - 25 bar (PN25) A.R.I. K-065 NS 0.2 - 40 bar (PN40)
Testing pressure	1.5 times maximum working pressure
Temperature	Maximum working temperature: 60° C Maximum intermittent temperature: 90° C

Upon ordering, please specify: model, size, working pressure, thread / flange standard and type of liquid

The isolation valve installed under the air valve must be fully open to prevent damage or malfunction and ensure performance within the specifications of the air valve.

For complete installation instructions, please refer to the IOM document.

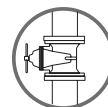

Valve Selection Options

Models	A.R.I. K-060 NS A.R.I. K-062 NS A.R.I. K-065 NS
Valve connection	Threaded male BSPT/NPT (1", 2") Flanged ends to meet various requested standard (2"-10")
Standard materials	Cast Stainless Steel 316
Pressure rating	PN16 A.R.I. K-060 NS PN25 A.R.I. K-062 NS PN40 A.R.I. K-065 NS
Additional product configurations	SB Underground Air Valve System

Dimensions and Weight

Model	Size	Dimensions (mm)		Connections	Weight (kg)	Orifice Area (mm ²)
		max. A	B			
A.R.I. K-060 NS						
Horizontal Outlet	1" (25mm) THR	193	239	1½" Female	4	507
	2" (50mm) THR	267	277	2" Female	11	1960
	2" (50mm) FL	277	256	2" Female	12	1960
	3" (80mm) FL	342	345	3" Female	20	5030
	4" (100mm) FL	411	418	4" Female	31	7850
Screen Cover	6" (150mm) FL	381	614	6" Female	77	17662
	8" (200mm) FL	463	741	-	155	31400
	10" (250mm) FL	586	904	-	290	49087
A.R.I. K-062 NS						
Horizontal Outlet	1" (25mm) THR	193	239	1½" Female	5	507
	2" (50mm) THR	267	277	2" Female	11	1960
	2" (50mm) FL	277	256	2" Female	13	1960
	3" (80mm) FL	342	345	3" Female	21	5030
	4" (100mm) FL	411	418	4" Female	32	7850
Screen Cover	6" (150mm) FL	381	616	6" Female	92	17662
	8" (200mm) FL	463	747	-	156	31400
	10" (250mm) FL	586	904	-	290	49087
A.R.I. K-065 NS						
Horizontal Outlet	2" (50mm) THR	267	277	2" Female	10	1960
	2" (50mm) FL	277	256	2" Female	12	1960
	3" (80mm) FL	342	345	3" Female	20	5030
	4" (100mm) FL	411	418	4" Female	31	7850
Screen Cover	6" (150mm) FL	381	616	-	90	17662
	8" (200mm) FL	463	752	-	147	31400

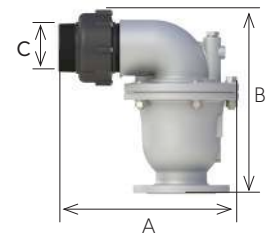

FL - Flanged THR - Threaded

NOTE

Dimension A in the picture and in the table shows the maximum product width. This width can be reduced by changing the cover direction. All product weights are approximate, due to the differences in flange standards, materials and variable accessories.

Flow Charts Horizontal Outlet Models

1" Adjustable NS Check Valve

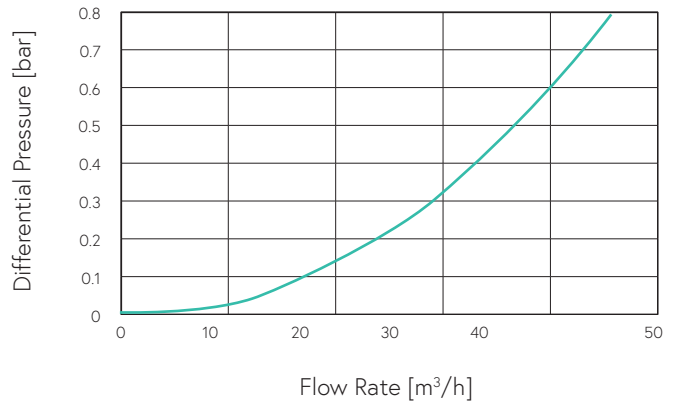
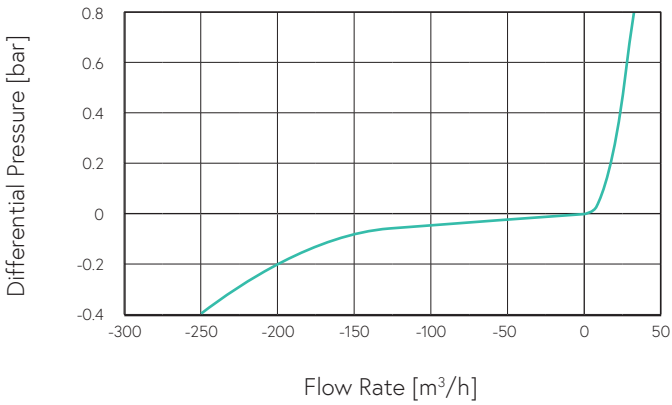

2" Adjustable NS Check Valve

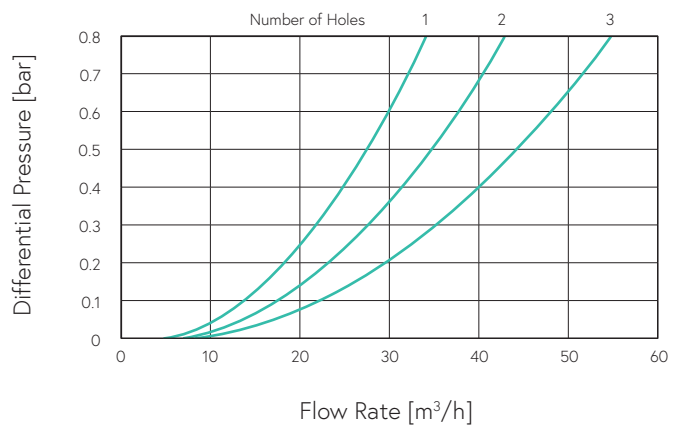
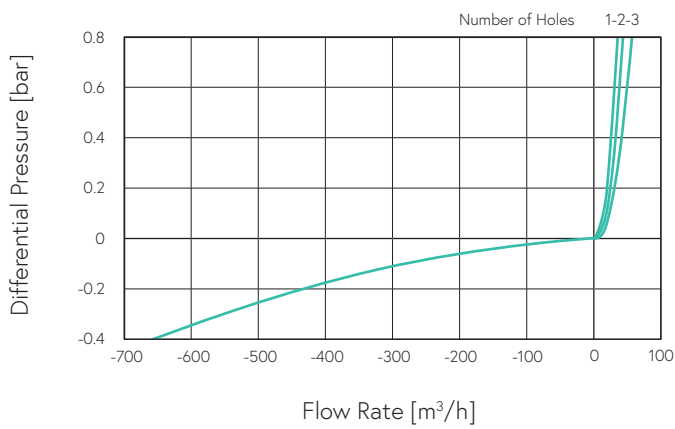

3" Adjustable NS Check Valve

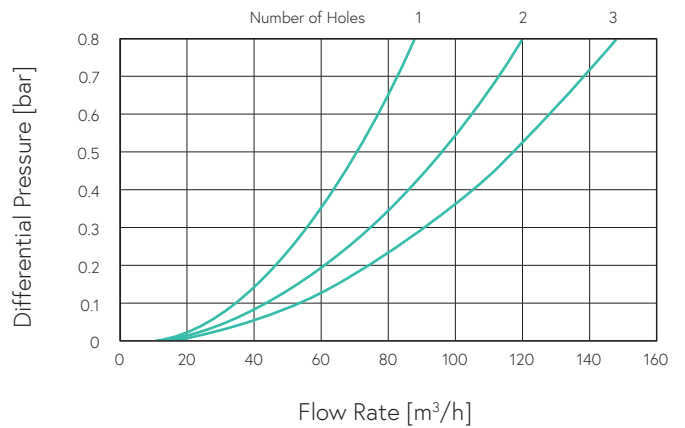
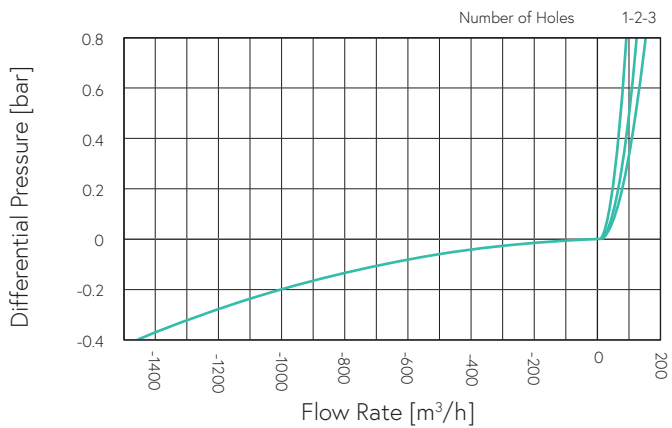

Flow Charts

Horizontal Outlet Models

4" Adjustable NS Check Valve

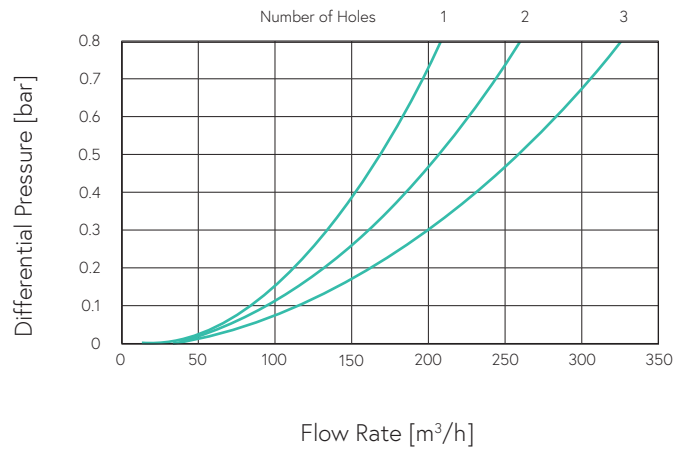
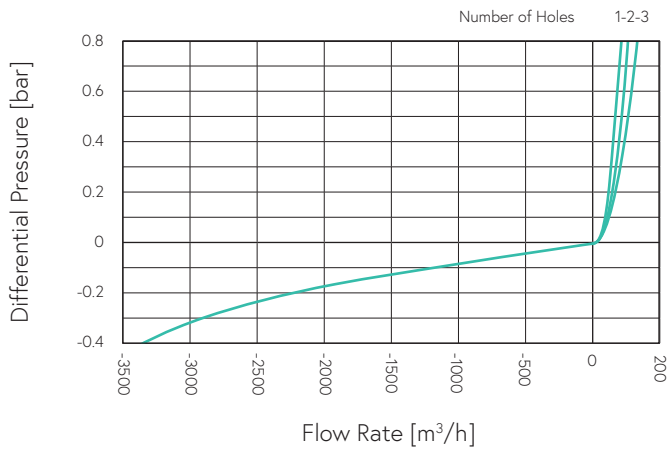

Screen Cover Models

Air & Vacuum Flow Rate

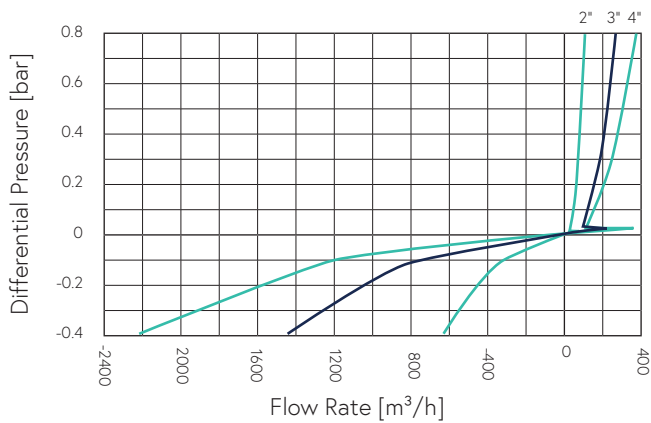

Air Discharge Switching Region

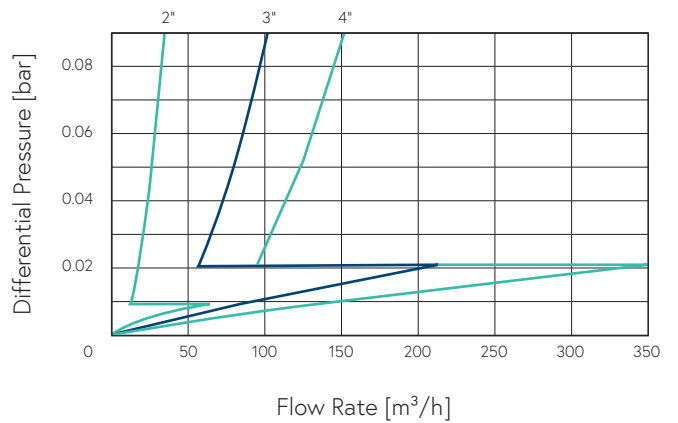

Air & Vacuum Flow Rate

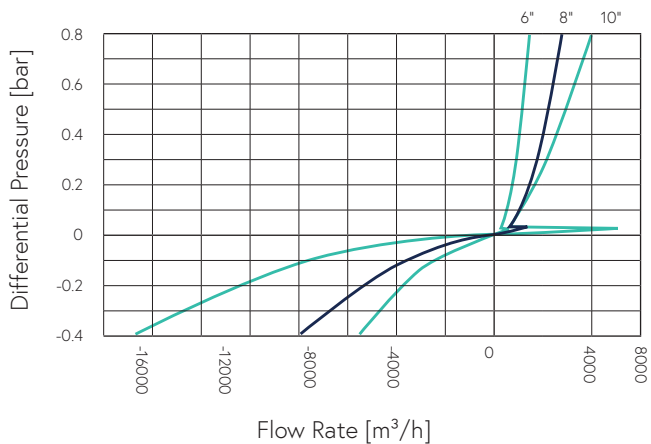

Air Discharge Switching Region

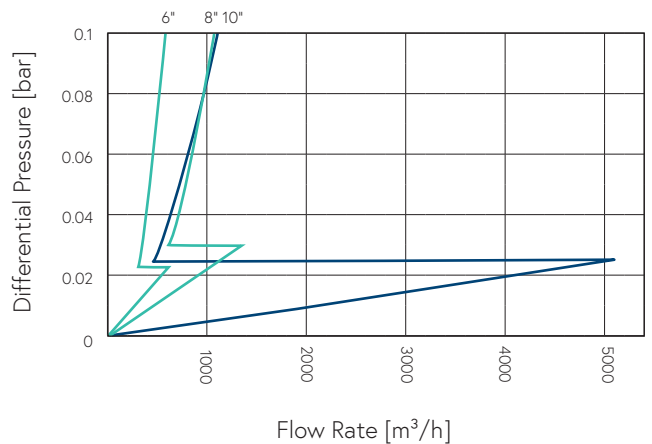

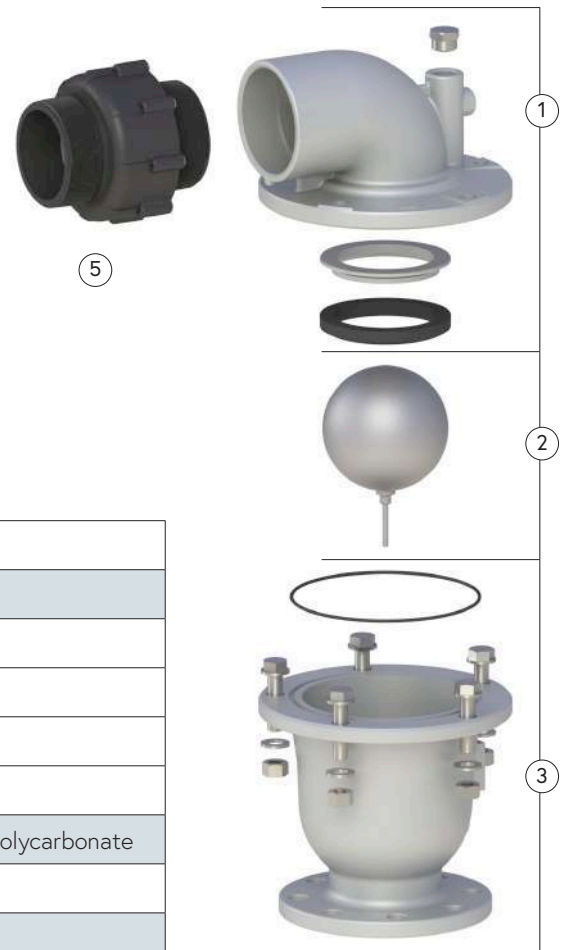

Parts List and Specifications

1"-4" Horizontal Outlet Models

No.	Part	Material
1	Cover Assembly	
1a	Cover	Stainless Steel 316, Super Duplex
1b	Orifice Seat	Stainless Steel 316, Super Duplex
1c	Orifice Seal	EPDM, Viton
2	Float	Stainless Steel 316, Super Duplex, Polycarbonate
3	Body Assembly	
3a	O-ring	EPDM, Viton
3b	Bolts, Nuts & Washers	Steel/Stainless Steel 316
3c	Body	Stainless Steel 316, Super Duplex
4	Non-slam Assy.	Polypropylene / Reinforced Nylon

Parts List and Specifications

6"-10" Screen Cover Models

No.	Part	Material
1	Cover Assembly	
1a	Screen Cover	Polypropylene
1b	Screen	Stainless Steel 316
1c	Bolts, Nuts & Washers	Stainless Steel 316
1d	Locking Ring	Stainless Steel 316
1e	Non-slam Disc Assy.	Stainless Steel 316
1f	Cover	Stainless Steel 316, Super Duplex
1g	Orifice Seat	Stainless Steel 316, Super Duplex
1h	Orifice Seal	EPDM, Viton
2	Float	
2a	Float	Stainless Steel 316, Super Duplex, Polycarbonate
3	Body Assembly	
3a	O-ring	EPDM, Viton
3b	Bolts, Nuts & Washers	Steel/Stainless Steel 316
3c	Body	Stainless Steel 316, Super Duplex

